

Zusammenstellung

B.S DFA 052 D compact A.S

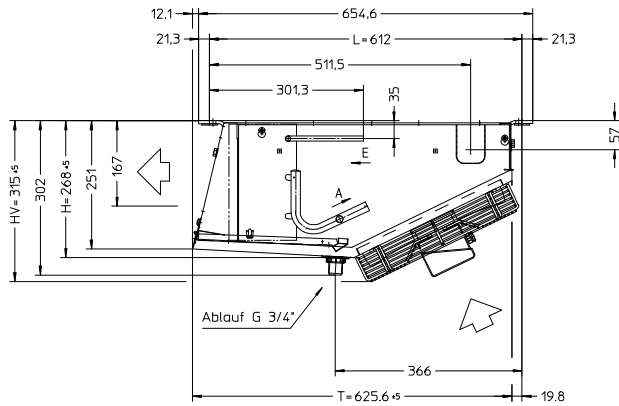

E (Inlet) = $\varnothing 10 \times 1,0$ mm

A (Outlet) = $\varnothing 18 \times 1,0$ mm

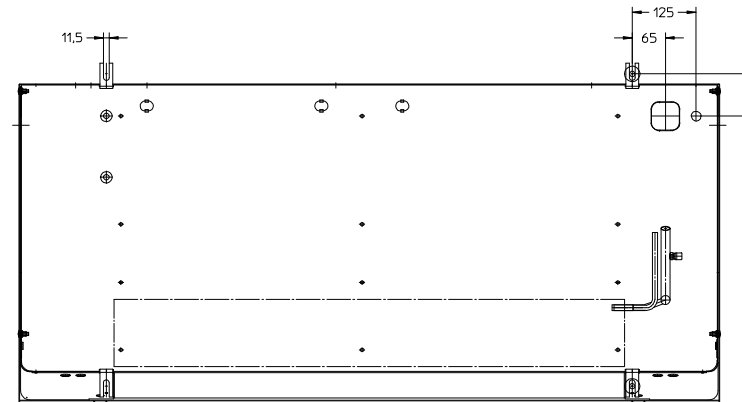
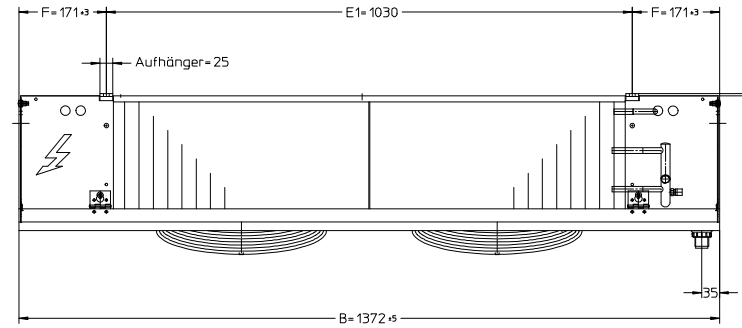
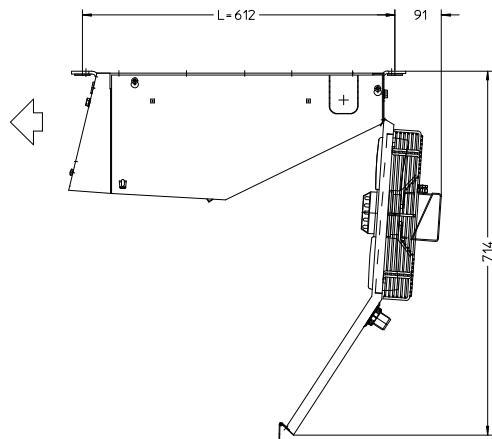

compact DF

4320.052 DFA 052 D
4321.052 DFAE 052 D