

Zusammenstellung

B.S

DFA 063 D compact

A.S

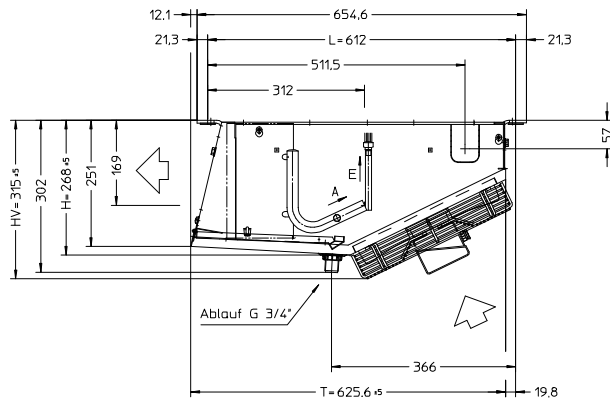

E (Inlet) =  $\varnothing 12 \times 1,0$  mm

A (Outlet) =  $\varnothing 22 \times 1,0$  mm

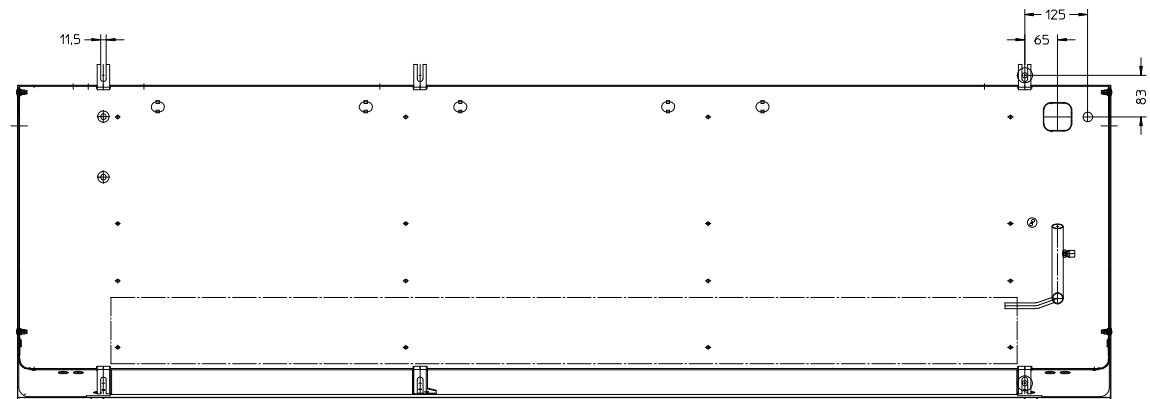
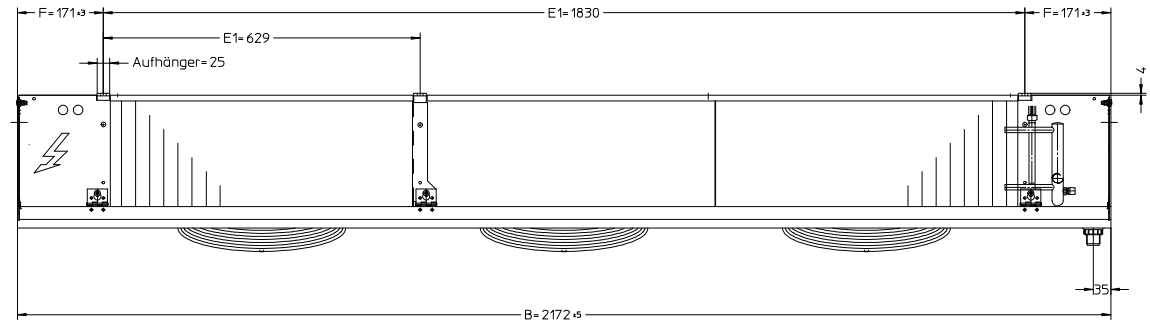
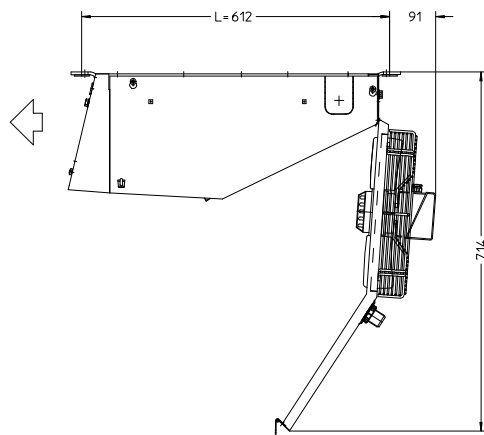

compact DF

4320.063 DFA 063 D  
4321.063 DFAE 063 D