

Zusammenstellung

B.S DFA 071 D compact A.S

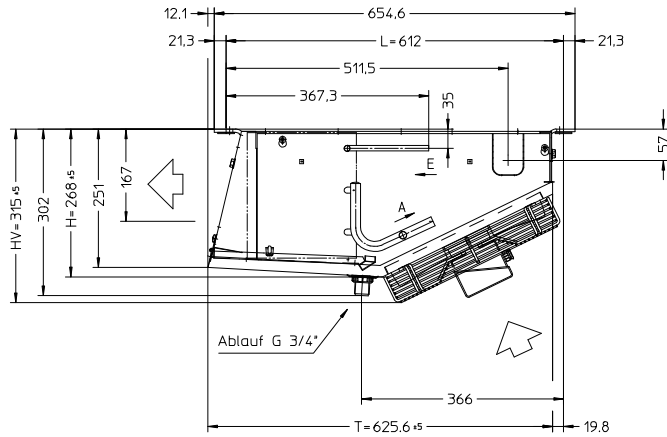

E (Inlet) = $\varnothing 10 \times 1,0$ mm

A (Outlet) = $\varnothing 18 \times 1,0$ mm

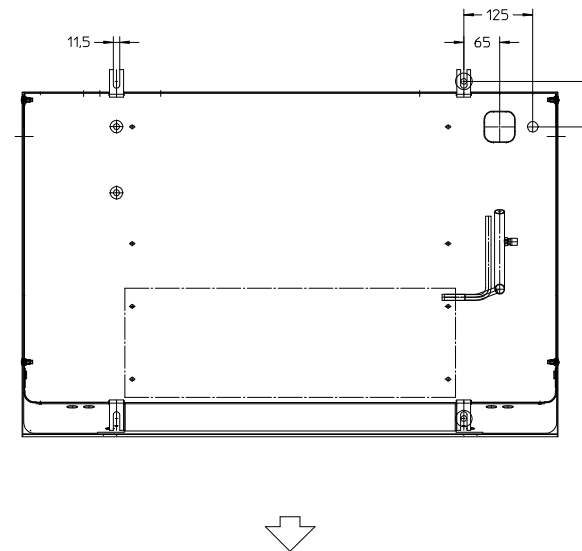
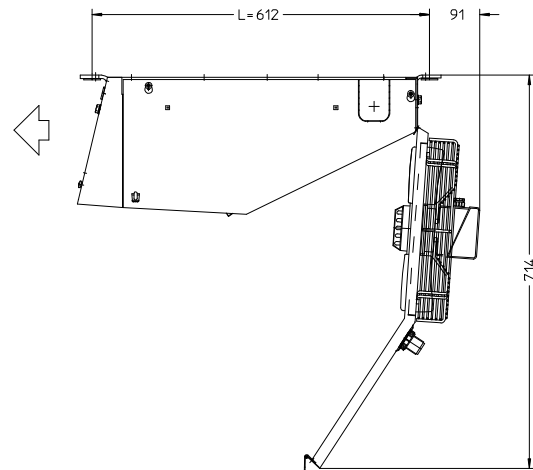
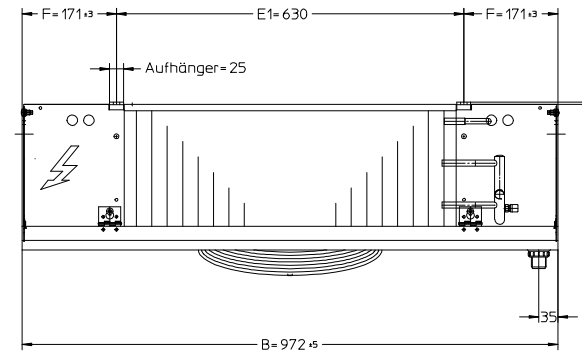

compact

DF

4320.071

DFA 071 D

4321.071

DFAE 071 D