

Zusammenstellung

B.S DFA 072 D compact A.S

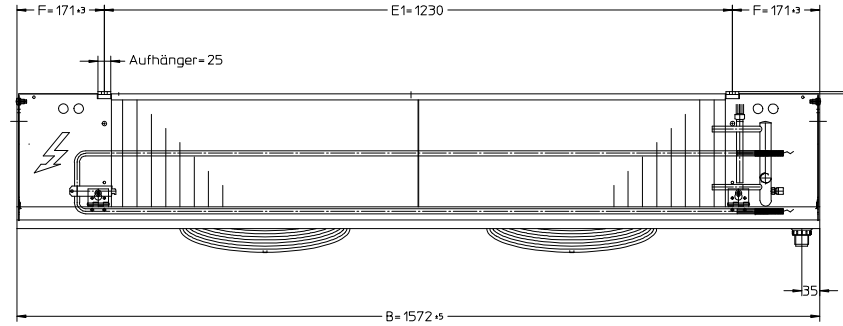
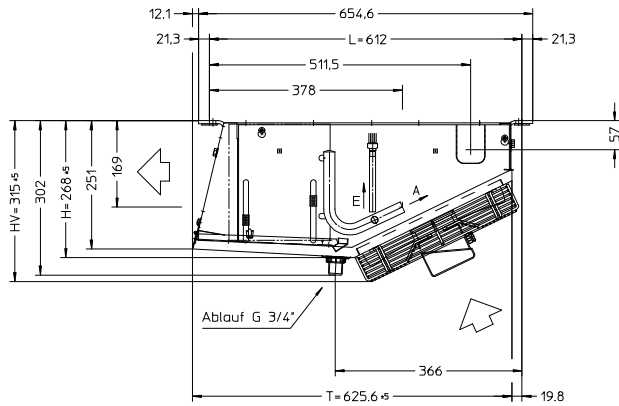

E (Inlet) = $\varnothing 12 \times 1.0$ mm

A (Outlet) = $\varnothing 22 \times 1.0$ mm

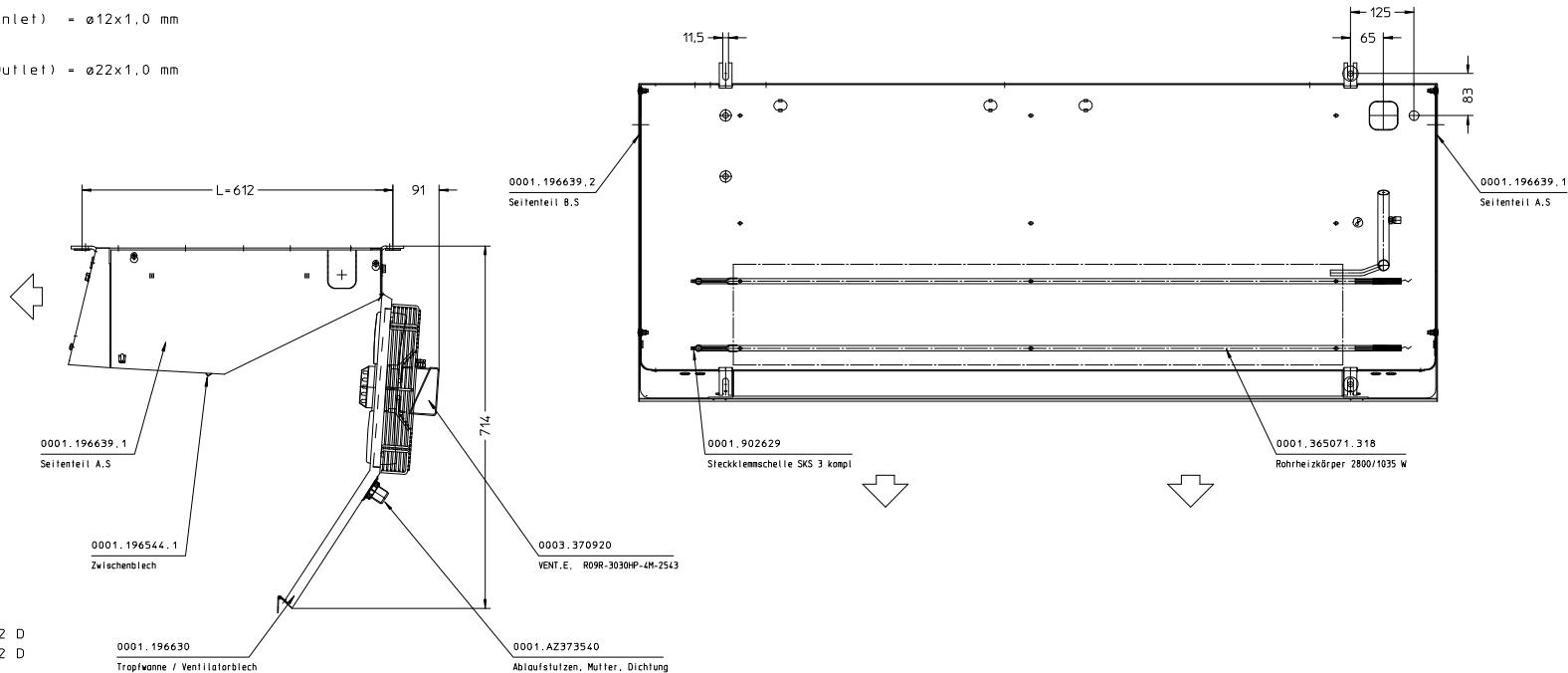

compact DF

4320.072 DFA 072 D
4321.072 DFAE 072 D