

E (Inlet) =  $\varnothing 10 \times 1,0$  mm

A (Outlet) =  $\varnothing 12 \times 1,0$  mm

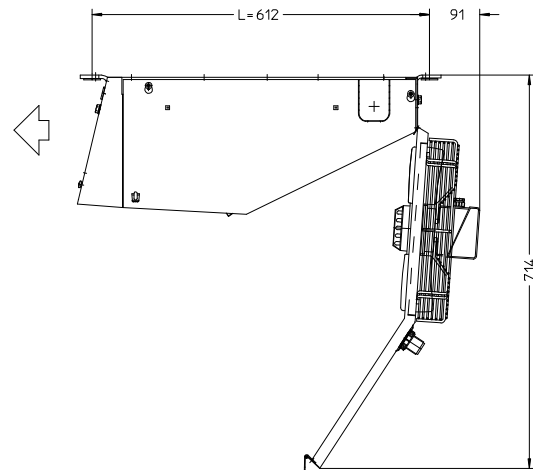

Zusammenstellung

B.S DFB 061 D compact A.S

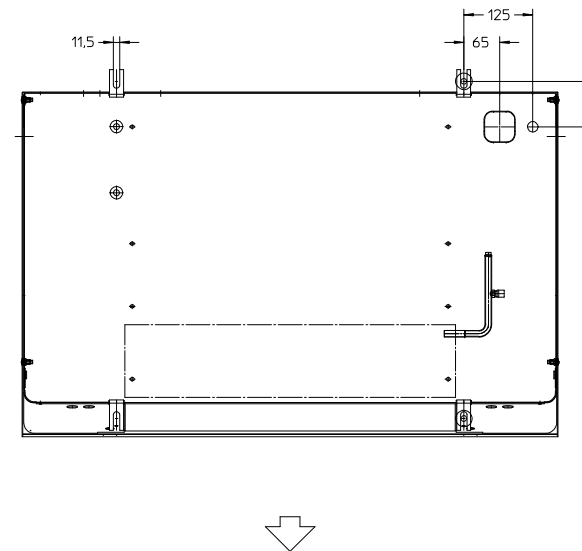
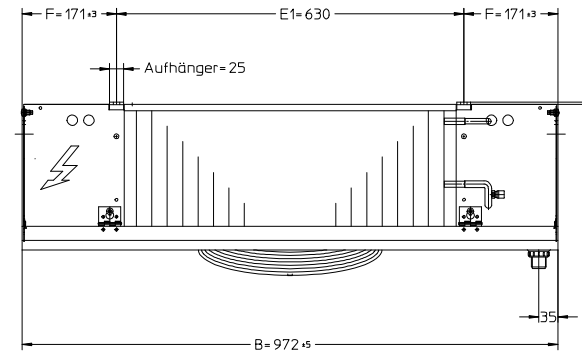

compact

DF

4322.061

DFB 061 D

4323.061

DFBE 061 D