

Zusammenstellung

B.S DFB 062 D compact A.S

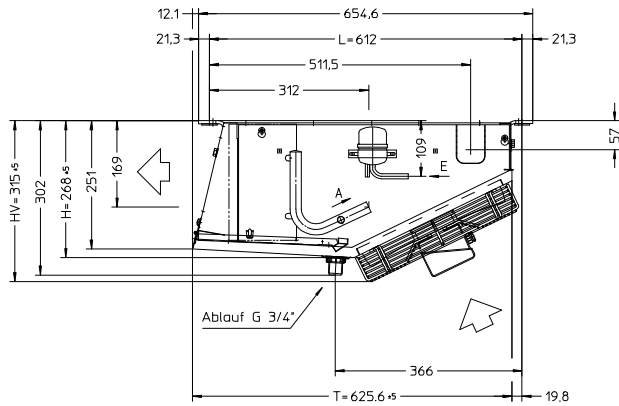

E (Inlet) = $\varnothing 10 \times 1.0$ mm

A (Outlet) = $\varnothing 22 \times 1.0$ mm

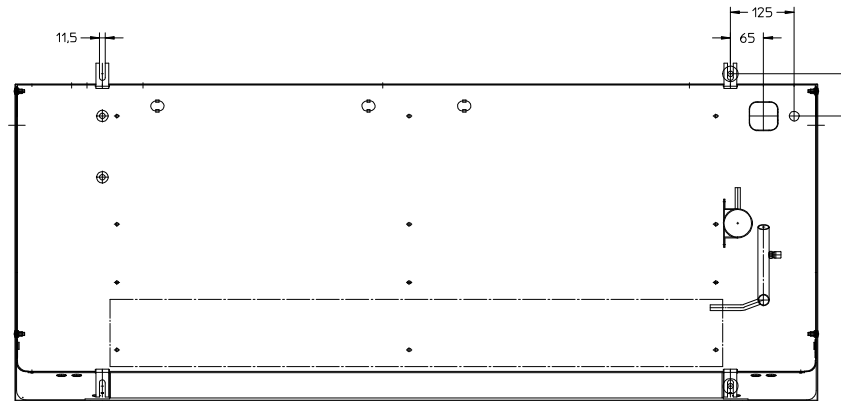
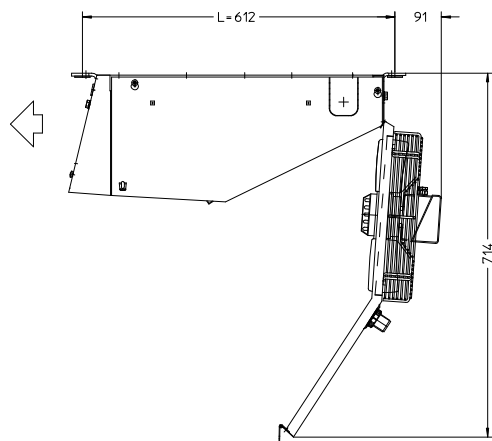
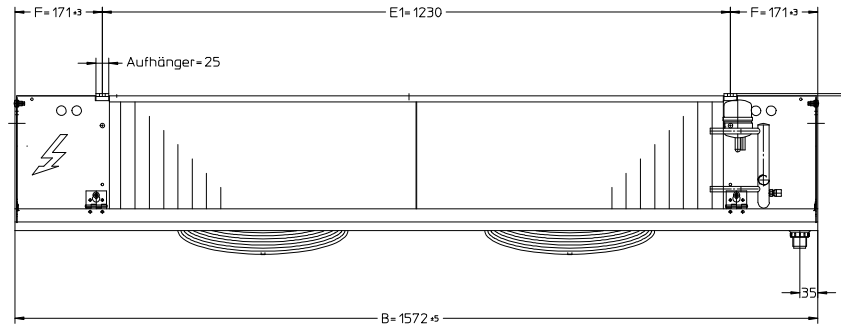

compact DF

4322.062 DFB 062 D
4323.062 DFBE 062 D