

E (Inlet) = $\varnothing 10 \times 1,0$ mm

A (Outlet) = $\varnothing 18 \times 1,0$ mm

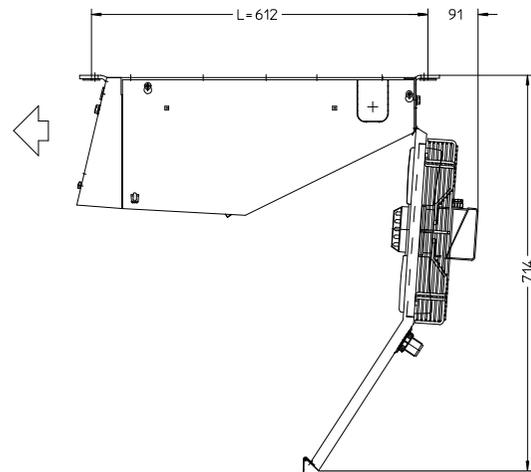

Zusammenstellung

B.S DFB 071 D compact A.S

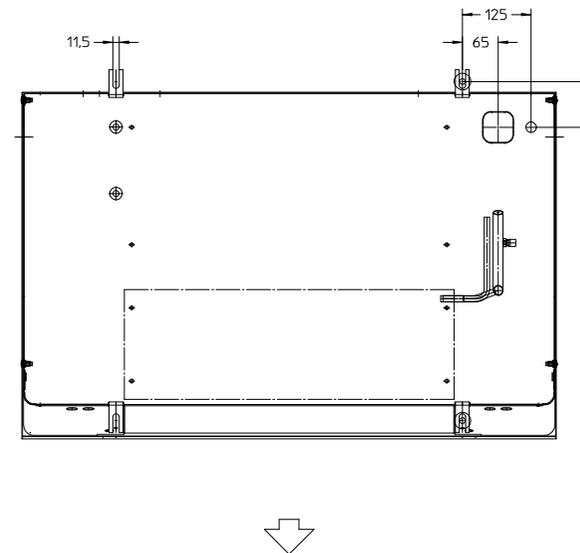
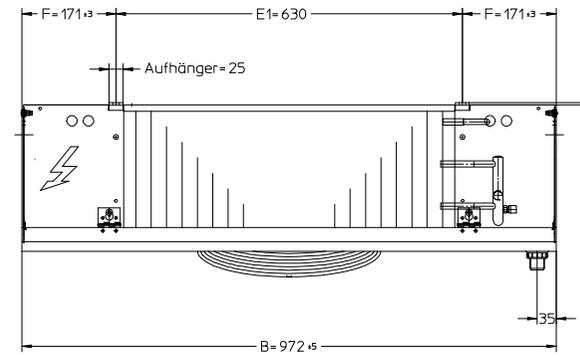

compact

DF

4322.071

DFB 071 D

4323.071

DFBE 071 D