

Zusammenstellung

B.S DFB 074 D compact A.S

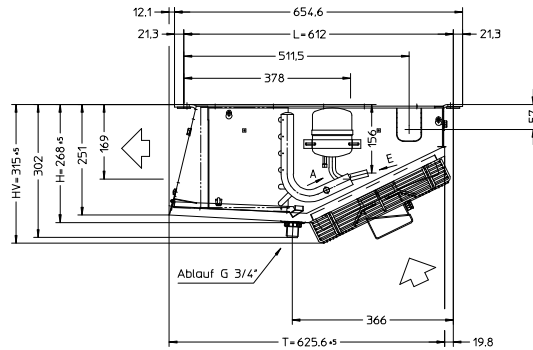

E (Inlet) = $\varnothing 15 \times 1,0$ mm

A (Outlet) = $\varnothing 28 \times 1,5$ mm

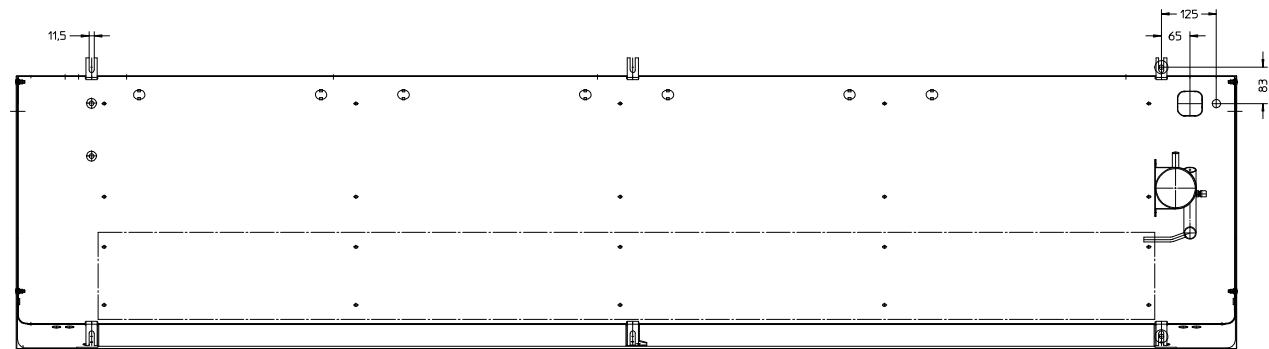
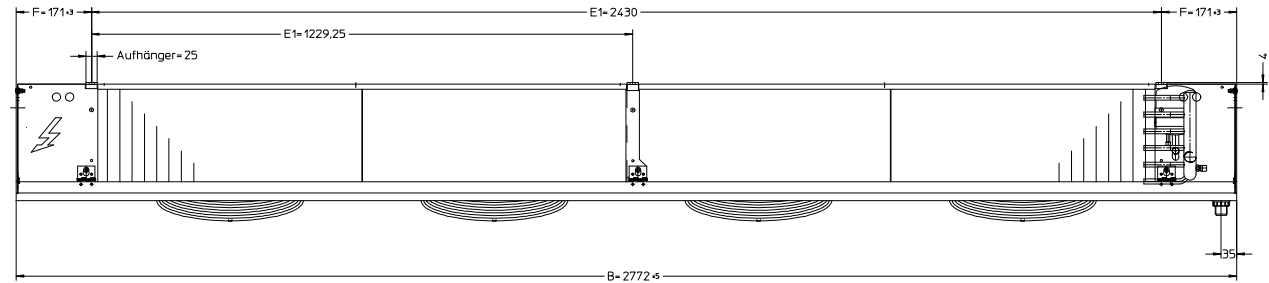
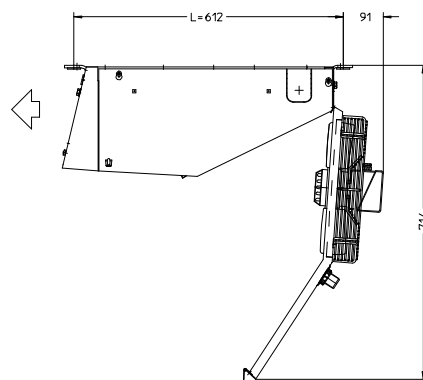

compact DF

4322.074 DFB 074 D
4323.074 DFBE 074 D